



Monnit Wi-Fi Dry Contact Sensor



Technical Overview

General Description

The Monnit Wi-Fi Dry Contact Sensor can be used to detect contact between two wired contact points that can be used with an external mechanical switch or a contact plate. An integrated 802.11 b/g radio allows the sensor to work with any existing Wi-Fi network. Monnit Wi-Fi sensors can be easily programmed with your Wi-Fi network's WEP or WPA(2) security via the free MoWi Setup Utility (PC application) and a MoWi USB programming cable (available in the [Monnit web store](#)).

Features

- Senses immediate contact between wires.
- Can also sense when contact is broken.
- Product comes with standard 12 inch lead.
- Logs data if Wi-Fi network is disrupted.
- Free iMonnit basic online wireless sensor monitoring and notification system to configure sensors, view data and set alerts via SMS text and email.

Principle of Operation

The Monnit Wi-Fi Dry Contact Sensor detects when their is contact between the two wired end points. It can easily be integrated into existing switches or contact plates. When the sensor detects contact between the two end points, it will immediately turn on the RF radio and transmit the data to the wireless gateway and iMonnit Online Sensor Monitoring and Notification System, allowing the user to immediately receive an SMS text or email alert. The sensor can be configured to detect both closed and open loops alerting if contact is made or broken.

High Gain Antenna Option

Monnit Wi-Fi sensors are also available with a detachable high gain antenna to provide a 20-30% increase in range over the standard Wi-Fi sensor. Option uses a different hardware configuration and must be chosen at time of purchase.



Monnit Wi-Fi Sensor Electronics Specifications

- Power: 2 replaceable 1.5V "AA" batteries (included)
- Communication: 802.11 b/g
(2.412 - 2.484 GHz)
- Wi-Fi Security: Open, WEP, WPA, WPA2
- Dimensions: 3.02" x 2.1" x 1.27"
- Transmission Range: Up to 100 ft. *
- Battery Life: Up to 5 years.**

* Actual range may vary depending on environment.
** Battery life is affected by sensor type, Wi-Fi security type, distance from Wi-Fi router, reporting frequency and other variables.

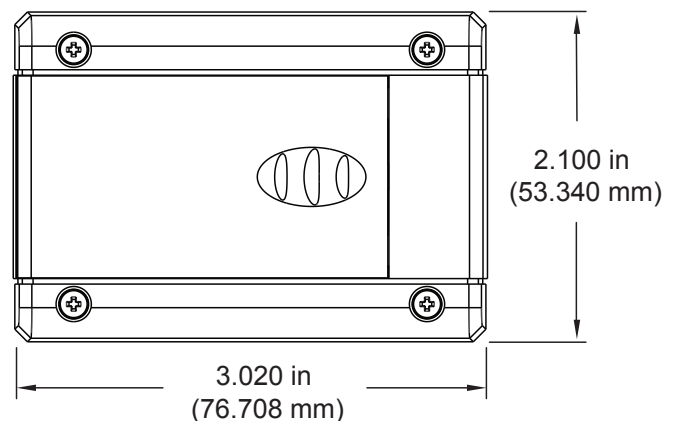

Height: 1.270 in (32.258 mm)



Applications

- Warehouse door monitoring.
- Freezer / cooler door monitoring.
- Forklift seat switches.
- Button or switch integration.
- Production line tracking.

The Leader in Low Cost Wireless Sensors

Technical Specifications	
Networking Standards	IEEE 802.11 b/g
Frequency Band	2.412 - 2.484 GHz
Wi-Fi Security Standards	Open, WEP, WPA, WPA2
Wi-Fi Security Programming	Via PC software using USB cable. (Can be changed through iMonnit online software.)
Network Settings	Auto DHCP/DNS or Static
Data Logging	Standard - On Wi-Fi disruption, unit will log the first 50 readings and transmit when Wi-Fi connection is re-established. Premiere - Unit can record up to 50,000 readings and transmit when Wi-Fi is available.
Power consumption	4uA sleep, 35mA active RX, 180mA TX (at +12dBm)
Battery Life	Up to 5 years depending on sensor type, Wi-Fi security, distance from Wi-Fi router, reporting frequency and other variables. (Testing surpassed 90,000 transmissions until battery depletion.)
Wi-Fi Data Rate	Auto configures to best rate for maximum range.
Wireless Range	Up to 100 ft. device range (typical to standard Wi-Fi devices).
Electronics Operating Temperature	Using Alkaline Batteries: -18°C to +55°C (0°F to +130°F) Using Lithium Batteries: -40°C to +85°C (-40°F to +185°F)
LED Light	Status / activity
Lead Wire Length	1 ft. (12 in.)
Certifications	   FCC ID: T9J-RN171. IC: RSS-210 low-power communication device. CE ID: 0681.

- * Hardware cannot withstand negative voltage. Please take care when connecting a power device.
- ** At temperatures above 100°C, it is possible for the board circuitry to lose programmed memory.

Caution/Notice:

This product is designed for application in an ordinary environment (normal room temperature, humidity and atmospheric pressure). Do not use this sensor under the following conditions as they can deteriorate the product characteristics and cause failures and burn-out.

- Corrosive gas or deoxidizing gas - chlorine gas, hydrogen sulfide gas, ammonia gas, sulfuric acid gas, nitric oxides gas, etc.).
- Volatile or flammable gas.
- Dusty conditions.
- Under low or high pressure.
- Wet or excessively humid locations.
- Places with salt water, oils chemical liquids or organic solvents.
- Where there are excessively strong vibrations.
- Other places where similar hazardous conditions exist.

Use this product within the specified temperature range. Higher temperature may cause deterioration of the characteristics or the material quality of this product.



For more information about our products or to place an order, please contact our sales department at 801-561-5555 or visit us on the web at www.monnit.com.

Monnit Corporation
4403 South 500 West
Murray, UT 84123
801-561-5555
www.monnit.com