

Wireless 0-10 Volt Meter Sensor

General Description

The Monnit Wireless Voltage Meter measures the voltage between two electrical points. It can be connected to the power and ground of any voltage source and measure within stated accuracy up to 10 VDC. The sensor can be connected to any kind of variable voltage device, such as a transducer or sensor that outputs voltage. If the device to be measured is passive, the user must supply their own excitation voltage to the device.

- Accurate to $\pm 3.0\%$ full scale (FS) of voltage range.
- Accurate to $\pm 0.5\%$ FS with user calibration.
- Interfaces with any variable voltage device.
- 5 mV Resolution.



Free iMonnit basic online wireless sensor monitoring and notification system to configure sensors, view data and set alerts via SMS text and email.

Principle of Operation

Monnit Wireless Voltage Meters read the difference in voltage between two electrical points and reports back the measured voltage. It is programmed to sleep for a user-given time interval (heartbeat) and then wake up, convert the analog data, mathematically compute the voltage, and transmit the data to the gateway, where it is then logged into a cloud service. The user can configure defined thresholds and have the system issue alerts on threshold breaches.

Example Interfacing

- Battery Health
- Voltage Measurement
- Transducer Measurement
- Machinery
- Electrical Motors
- And many more...

Monnit Sensor Core Specifications

- Wireless Range: 250 - 300 ft. (non line-of-sight / indoors / through walls, ceilings & floors) *
- Communication: RF 900, 920, 868 and 433 MHz
- Power: Replaceable batteries (optimized for long battery life) - Line-power (AA version) and solar (Industrial version) options available
- Battery Life (at 1 hour heartbeat setting) **
 - AA battery > 4-8 years
 - Coin Cell > 2-3 years.
 - Industrial > 4-8 years

* Actual range may vary depending on environment.

** Battery life is determined by sensor reporting frequency and other variables.

Sensor Types & Options

Wireless 0-10 Volt Meter Sensor (AA)	2
Wireless 0-10 Volt Meter Sensor (Coin Cell)	3
Wireless 0-10 Volt Meter Sensor (Industrial)	4
Notes	5

Wireless 0-10 Volt Meter Sensor (AA)

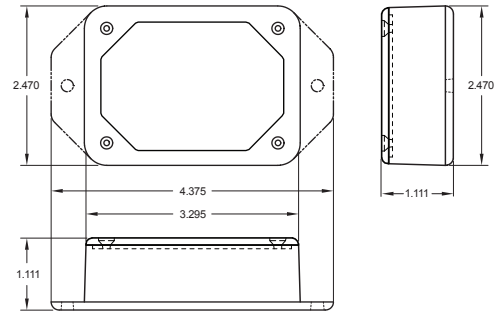

Technical Specifications	
Supply Voltage	2.0 - 3.6 VDC * (3.0 - 3.6 VDC Using Power Supply)
Current Consumption	0.7 μ A (sleep mode) 2 mA (radio idle/off mode) 2 mA (measurement mode) 25 mA (radio RX mode) 35 mA (radio TX mode)
Operating Temperature Range (Board Circuitry and Batteries)	-18°C to 55°C (0°F to 130°F) using alkaline -40°C to 85°C (-40°F to 185°F) using lithium **
Optimal Battery Temperature Range (AA)	+10°C to +50°C (+50°F to +122°F)
Voltage Range	0 – 10 Volts DC***
Resolution	~5 mV
Accuracy	+/- 3% FS
User Calibrated Accuracy	+/- .5% FS ****
Open Circuit Voltage	~0.000 Volts
Max Rated Input	20 Volts
Leaded Wire Specification	2 Wires, 1 ft. (12 in.), Red (+), Black (-), 18 AWG (Custom lengths available upon request)
Weight	4.0 oz.
Wireless Range	250 - 300 ft. (Indoors /Through walls, ceilings & floors) Range may vary according to environmental variables
Certifications	900 MHz product; FCC ID: ZTL- RFSC1 and IC: 9794A-RFSC1. 920 MHz product; ARIB STD-T108 R210-103733. 868 and 433 MHz product tested and found to comply with: CISPR 22:2008-09 / EN 55022:2010 - Class B and ETSI EN 300 220-2 V2.4.1 (2012-05).



- * Hardware cannot withstand negative voltage. Please take care when connecting a power device.
- ** At temperatures above 100°C, it is possible for the board circuitry to lose programmed memory.
- *** The sensor is capable of measuring above 10 volts but may not meet the specified accuracy above this value.
- **** For best results calibrate at a voltage between 50% and 90% of the voltage range.

Proper Installation

If the sensor is not connected to the power source properly, it will appear that the sensor is broken. Please follow this wiring diagram to ensure proper performance and detection.

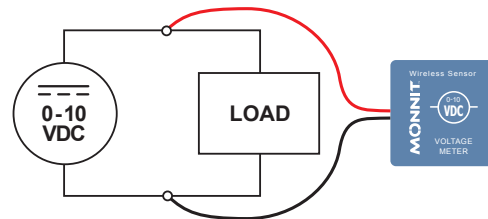

Power Options

Two replaceable 1.5V AA sized batteries are included with the standard model. A line-power version with battery backup is also available - allowing it to be powered by a standard 3.0 - 3.6V power supply and utilize the internal batteries if there is a power interruption.

Power options must be selected at time of purchase as the internal hardware of the sensor must be changed to support the selected power requirements.

Wireless 0-10 Volt Meter Sensor (Coin Cell)

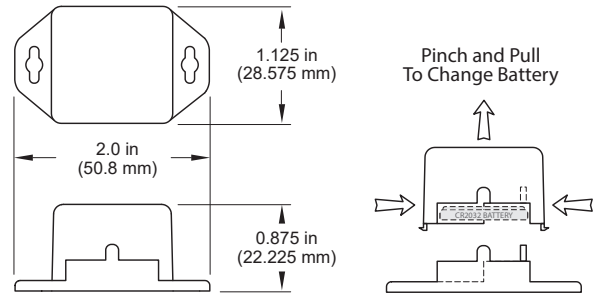

Technical Specifications	
Supply Voltage	2.0 - 3.6 VDC *
Current Consumption	0.7 μ A (sleep mode) 2 mA (radio idle/off mode) 2 mA (measurement mode) 25 mA (radio RX mode) 35 mA (radio TX mode)
Operating Temperature Range (Board Circuitry and Batteries)	-7°C to +60°C (20°F to +140°F) **
Optimal Battery Temperature Range (AA)	+10°C to +50°C (+50°F to +122°F)
Voltage Range	0 – 10 Volts DC***
Resolution	~5 mV
Accuracy	+/- 3% FS
User Calibrated Accuracy	+/- .5% FS ****
Open Circuit Voltage	~0.000 Volts
Max Rated Input	20 Volts
Leaded Wire Specification	2 Wires, 1 ft. (12 in.), Red (+), Black (-), 18 AWG (Custom lengths available upon request)
Weight	1.0 oz.
Wireless Range	250 - 300 ft. (Indoors /Through walls, ceilings & floors) Range may vary according to environmental variables
Certifications	900 MHz product; FCC ID: ZTL- RFSC1 and IC: 9794A-RFSC1. 920 MHz product; ARIB STD-T108 R210-103733. 868 and 433 MHz product tested and found to comply with: CISPR 22:2008-09 / EN 55022:2010 - Class B and ETSI EN 300 220-2 V2.4.1 (2012-05).



- * Hardware cannot withstand negative voltage. Please take care when connecting a power device.
- ** At temperatures above 100°C, it is possible for the board circuitry to lose programmed memory.
- *** The sensor is capable of measuring above 10 volts but may not meet the specified accuracy above this value.
- **** For best results calibrate at a voltage between 50% and 90% of the voltage range.

Proper Installation

If the sensor is not connected to the power source properly, it will appear that the sensor is broken. Please follow this wiring diagram to ensure proper performance and detection.

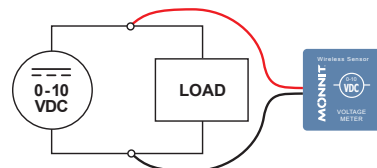

Power Options

Sensors are powered by a replaceable 3.0 V coin cell battery. Optional AA battery powered devices are also available. The AA version of these sensors are larger in size (3" [L] x 2.1" [W] x 1.2" [H]) and include two long-life AA batteries. It is recommended that unless you are using the AA battery solution, you set heartbeat to no faster than one hour to preserve battery life.

PinchPower™ Enclosure

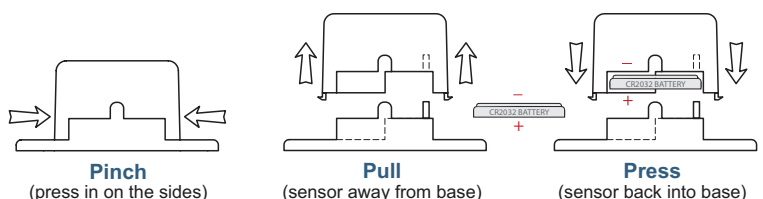

Wireless 0-10 Volt Meter Sensor (Industrial)

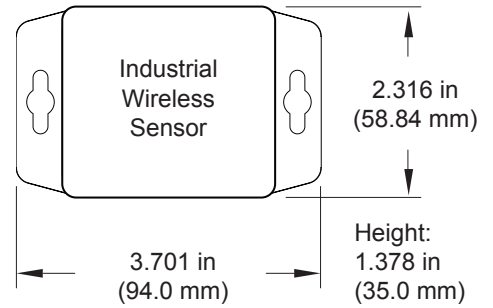

Technical Specifications

Supply Voltage	2.0 - 3.6 VDC *	
Current Consumption	0.7 μ A (sleep mode) 2 mA (radio idle/off mode) 2 mA (measurement mode) 25 mA (radio RX mode) 35 mA (radio TX mode)	
Operating Temperature Range (Board Circuitry and Batteries)		
Included Battery	Max Temperature Range:	-40°C to +85°C (-40°F to +185°F) **
	Capacity:	-40° to +85°C (-40° to +185°F)
Optional Solar Feature	Solar Panel:	1800 mAh
	Charging Temperature Range:	5VDC / 30mA (53mm x 30mm)
	Max Temperature Range:	0° to 45°C (32° to 113°F)
	Included Rechargeable Battery:	-20° to 60°C (-4° to 140°F)
Voltage Range	0 – 10 Volts DC***	
Resolution	~5 mV	
Accuracy	+/- 3% FS	
User Calibrated Accuracy	+/- .5% FS ****	
Open Circuit Voltage	~0.000 Volts	
Max Rated Input	20 Volts	
Leaded Wire Specification	2 Wires, 1 ft. (12 in.), Red (+), Black (-), 18 AWG (Custom lengths available upon request)	
Weight	5.0 oz.	
Enclosure Rating	NEMA 1, 2, 4, 4x, 12 and 13 rated, sealed & weather proof	
UL Rating	UL Listed to UL508-4x specifications (File E194432)	
Wireless Range	250 - 300 ft. (Indoors /Through walls, ceilings & floors) Range may vary according to environmental variables	
Certifications	 900 MHz product; FCC ID: ZTL- RFSC1 and IC: 9794A-RFSC1. 920 MHz product; ARIB STD-T108 R210-103733. 868 and 433 MHz product tested and found to comply with: CISPR 22:2008-09 / EN 55022:2010 - Class B and ETSI EN 300 220-2 V2.4.1 (2012-05).	

- * Hardware cannot withstand negative voltage. Please take care when connecting a power device.
- ** At temperatures above 100°C, it is possible for the board circuitry to lose programmed memory.
- *** The sensor is capable of measuring above 10 volts but may not meet the specified accuracy above this value.
- **** For best results calibrate at a voltage between 50% and 90% of the voltage range.

Proper Installation

If the sensor is not connected to the power source properly, it will appear that the sensor is broken. Please follow this wiring diagram to ensure proper performance and detection.

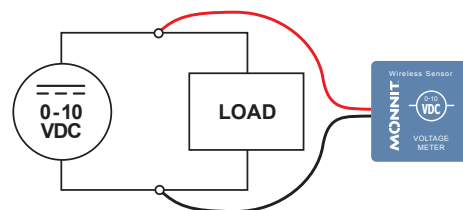

Notes

Commercial Grade Sensors

Monnit commercial grade sensors are designed for applications in ordinary environments (normal room temperature, humidity and atmospheric pressure). Do not use these sensors under the following conditions as these factors can deteriorate the product characteristics and cause failures and burn-out.

- Corrosive gas or deoxidizing gas - chlorine gas, hydrogen sulfide gas, ammonia gas, sulfuric acid gas, nitric oxides gas, etc.).
- Volatile or flammable gas.
- Dusty conditions.
- Under low or high pressure.
- Wet or excessively humid locations.
- Places with salt water, oils chemical liquids or organic solvents.
- Where there are excessively strong vibrations.
- Other places where similar hazardous conditions exist.

Use these products within the specified temperature range. Higher temperature may cause deterioration of the characteristics or the material quality.

Industrial Grade Sensors - Type 1, 2, 4, 4X, 12 and 13 NEMA Rated Enclosure

Monnit's Industrial sensors are enclosed in reliable, weatherproof NEMA rated enclosures. Our NEMA rated enclosures are constructed for both indoor or outdoor use and protect the sensor circuitry against the ingress of solid foreign objects like dust as well as the damaging effects of water (rain, sleet, snow, splashing water, and hose directed water).

- Safe from falling dirt.
- Protects against wind-blown dust.
- Protects against rain, sleet, snow, splashing water, and hose directed water
- Increased level of corrosion resistance
- Will remain undamaged by ice formation on the enclosure



For more information about our products or to place an order, please contact our sales department at 801-561-5555.

Visit us on the web at www.monnit.com.

Monnit Corporation
3400 South West Temple
Salt Lake City, UT 84115
801-561-5555
www.monnit.com